

10900418 Free Fall Fire Valve Tilt Switch - 12vDC 10900418

Landon Kingsway tilt switches are designed to be used in conjunction with our Free-Fall Valves / drop weight valves, they provide indication of valve position. Typically, they are used on generator feed lines, the valve will isolate the fuel in the event of a fire occurring, when the room reaches a certain temperature, it will melt the fusible link connected to the valve and isolate the fuel. The tilt switch can be mounted to the valve arm to notify the generator to shut down in the event of a fire.

The unit provides normally closed and normally open volt free contacts,

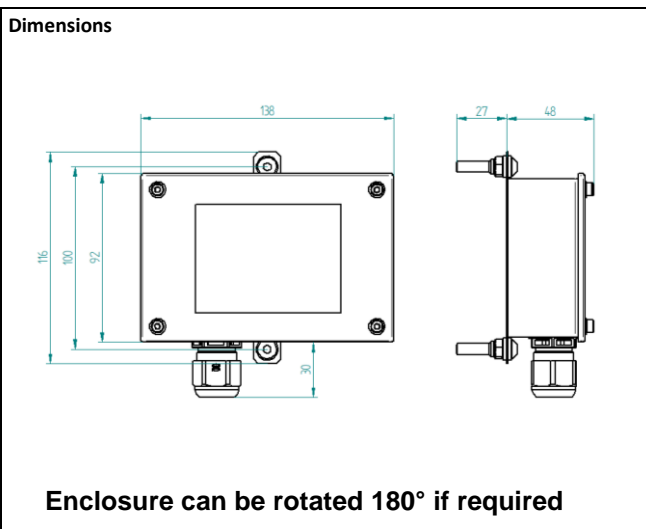

they are capable of switching AC or DC voltages.

INSTALLATION

The tilt switch enclosure should be securely fitted onto the valve lever using the supplied fixings. Care should be taken to ensure that the enclosure does not interfere with the motion of the valve lever. The electrical connections should be made through a cable gland or flexible conduit. **A 24vDC supply should be connected to terminals +/-.** Remember to leave enough slack in the cable for the valve lever movement. Electrical installation should only be performed by competent persons in accordance with the connection diagram.

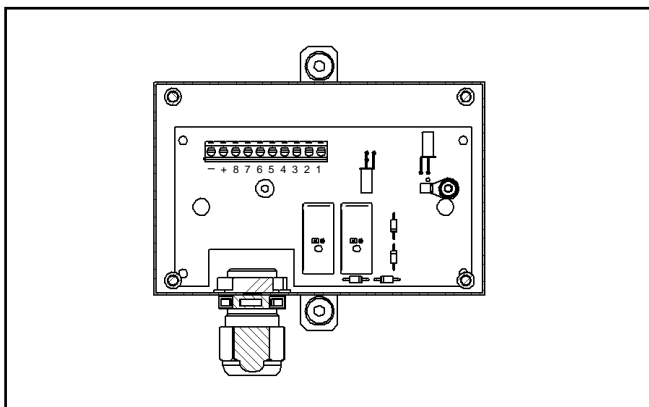

TEST

The fire valve should be operated manually with supply voltage before electrical power is applied through terminals 1,2,3,4,5,6,7 & 8 to the tilt switch, this will ensure that the electrical connections are correct.

Enclosure	Weatherproof grey epoxy coated steel plate. IP65
Fixing Centres	100mm
Electrical Entry	20mm conduit gland for cable diameter 6mm to 12mm
Supply Voltage	12vDC
Supply Load	600mW
Volt Free Contacts Terminal	(1&2) / (3&4) / (5&6) / (7&8)
Contact resistive load	4 Amps
Load Voltage (AC)	250vAC
Load Voltage (DC)	30vDC
Operating Temperature	-10°C to +50°C
Weight	0.2kg

Relay - UL Recognised
Vibration resistance (Destruction) 10 to 150Hz, 0.75 mm single amplitude (1.5 mm double amplitude)
Insulation resistance 1000Mohm
Shock resistance Destruction 980 m/s² Functional 98 m/s

Tilt switch attached to valve (Cover removed)

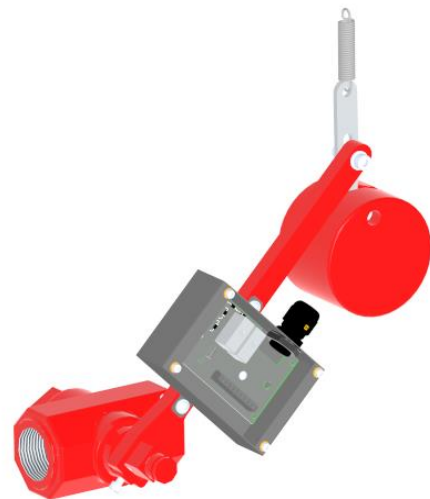

If you have any questions or need any help then please contact our sales office.



ROHS Compliant (Mercury Free)

10900418 Free Fall Fire Valve Tilt Switch - 12vDC

Tilt switch orientation and contact signal

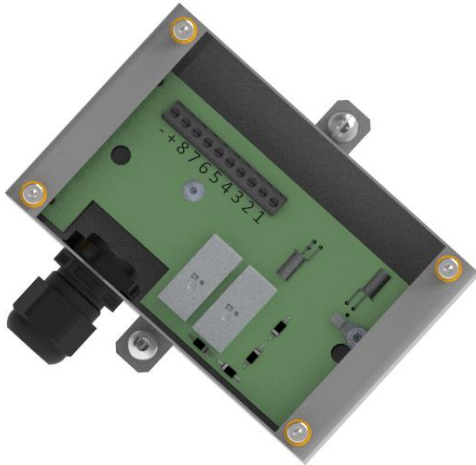

In the above mounted orientation (with supply power connected) the contact outputs are:

Terminal 1&2 = N/C Normally Closed
Terminal 3&4 = N/O Normally Closed
Terminal 5&6 = N/C Normally Closed
Terminal 7&8 = N/O Normally Closed

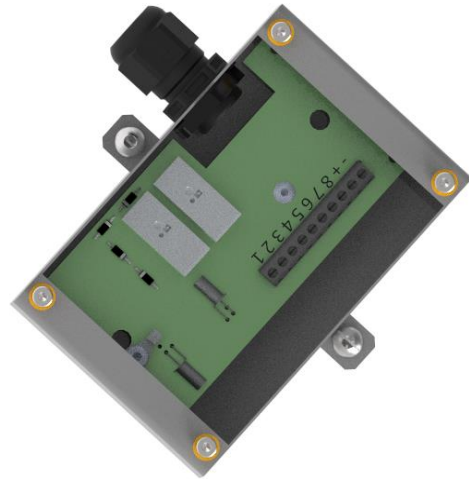

In the above mounted orientation (with supply power connected) the contact outputs are:

Terminal 1&2 = N/O Normally Closed
Terminal 3&4 = N/C Normally Closed
Terminal 5&6 = N/O Normally Closed
Terminal 7&8 = N/C Normally Closed

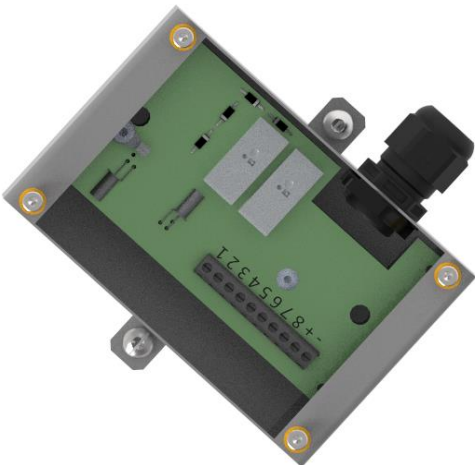

In the above mounted orientation (with supply power connected) the contact outputs are:

Terminal 1&2 = N/O Normally Closed
Terminal 3&4 = N/C Normally Closed
Terminal 5&6 = N/O Normally Closed
Terminal 7&8 = N/C Normally Closed

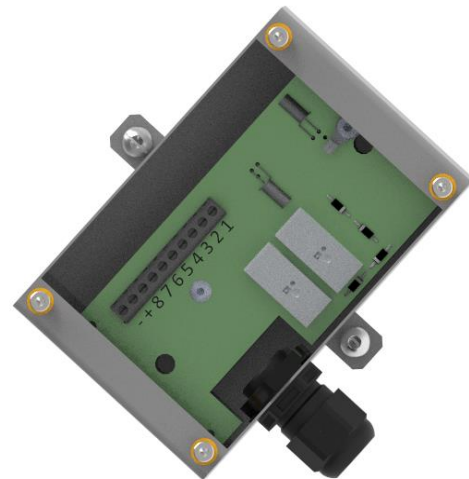

In the above mounted orientation (with supply power connected) the contact outputs are:

Terminal 1&2 = N/C Normally Closed
Terminal 3&4 = N/O Normally Closed
Terminal 5&6 = N/C Normally Closed
Terminal 7&8 = N/O Normally Closed