

PRODUCT SPECIFICATIONS



Post Office Box 97  
Benton Harbor, Michigan  
Ph: 269/926-6171  
Fax: 269/925-8288

PART NUMBER:  
STD113D

REV.  
A

Model Number	MAX. PRESS.		MAX. SPEED	HP	kW	Net Wt.	
	bar.	PSI				lbs.	kg
2AM-NCW-7ANLP	5,6	80	2,000 RPM	.55	0.40	4.2	1.9

SOUND LEVEL 76 dba MAX. CONFORMS TO EUROPEAN STANDARD EN13463-1  
 NORMAL AMBIENT +1°C. - 120°C. NON-ELECTRICAL EQUIPMENT FOR EXPLOSIVE  
 RELATIVE HUMIDITY 0% - 100% ATMOSPHERES GROUP II CAT 2 (GAS & DUST),  
 ENVIRONMENT HAZARDOUS AMBIENT COMBUSTIBLE PROTECTED BY CONSTRUCTION (SURFACE TEMP. RATED 135°C).  
GAS AND DUST +1°C TO +40°C

- NOTES:  
 1. CORROSION RESISTANT ROTOR ASSEMBLY, BODY & END PLATES.  
 2. UNIVERSAL VANE MATERIAL FOR OPERATING WITH OR WITHOUT LUBRICATION.  
 3. TECHNICAL DATA SUBJECT TO CHANGE WITHOUT NOTICE

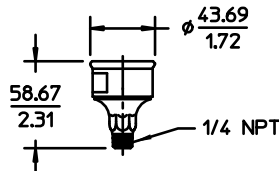
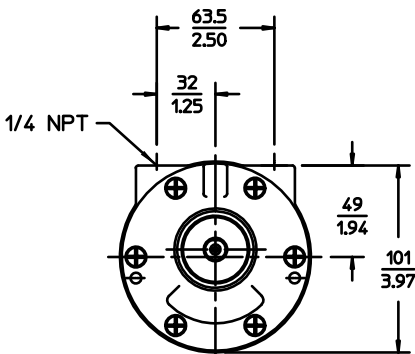
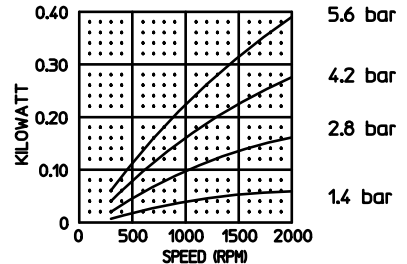
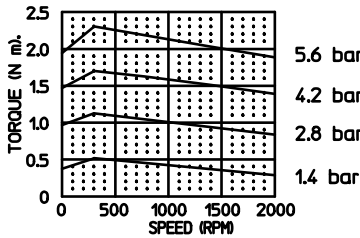
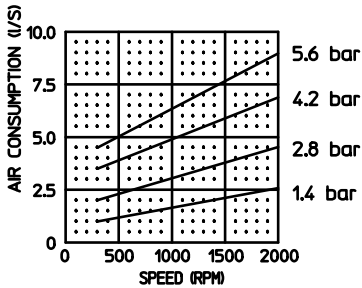
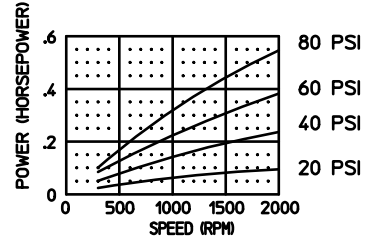
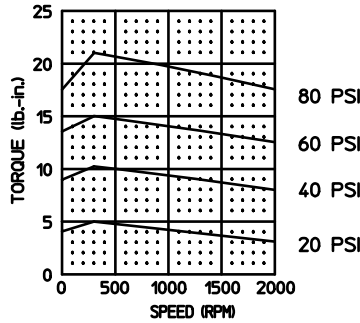
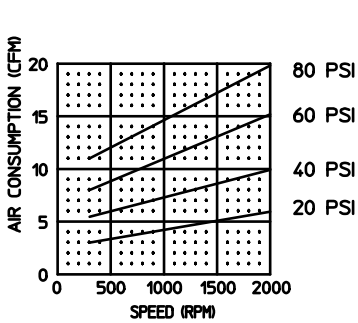

MUFFLER ASM.  
(SHIPPED UNATTACHED)



www.hccl.ie

